



**SMDJ**

**TVS**

**SURFACE MOUNT TRANSIENT VOLTAGE SUPPRESSORS**

■ **DESCRIPTION**

The UTC **SMDJ** is a surface mount transient voltage suppressors, it uses UTC's advanced technology to provide customers with low leakage and very fast response time, etc.

■ **FEATURES**

- \* Excellent clamping capability
- \* Low leakage
- \* Very fast response time

■ **SYMBOL**

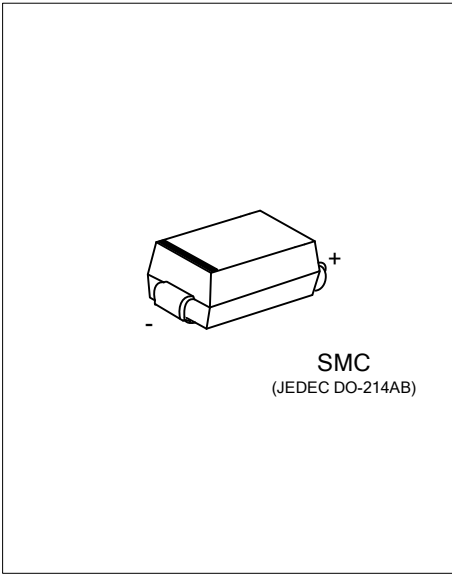
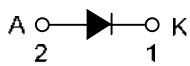

■ **ORDERING INFORMATION**

Ordering Number		Package	Pin Assignment		Packing
Lead Free	Halogen Free		1	2	
SMDJXXAL-SMC-R	SMDJXXAG-SMC-R	SMC	K	A	Tape Reel

Note: Pin Assignment: K: Cathode A: Anode

<p>SMDJXXAL-SMC-R</p> <ul style="list-style-type: none"> <li>(1) Packing Type</li> <li>(2) Package Type</li> <li>(3) Halogen Free</li> <li>(4) Category</li> <li>(5) Output Voltage Code</li> </ul>	<ul style="list-style-type: none"> <li>(1) R: Tape Reel</li> <li>(2) SMC: SMC</li> <li>(3) L: Lead Free, G: Halogen Free</li> <li>(4) A: 5% uni-directional</li> <li>(5) xx: refer to ELECTRICAL CHARACTERISTICS</li> </ul>
---	---

■ **MARKING**

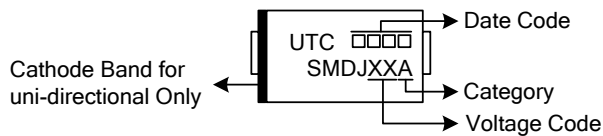

■ ABSOLUTE MAXIMUM RATING ( $T_A=25^\circ\text{C}$  unless otherwise noted)

PARAMETER	SYMBOL	RATINGS	UNIT
Peak Power Dissipation with a 10/1000 $\mu\text{s}$ Waveform (Note 2)	$P_{PP}$	3000	W
Peak Pulse Current with a 10/1000 $\mu\text{s}$ Waveform (Note 2)	$I_{PP}$	See ELECTRICAL CHARACTERISTICS Table	A
Power Dissipation On Infinite Heatsink at $T_L = 75^\circ\text{C}$	$P_D$	6.0	W
Peak Forward Surge Current, 8.3 ms Single Half Sine-wave Unidirectional Only (Note 3)	$I_{FSM}$	300	A
Maximum Instantaneous Forward Voltage at 50 A for Unidirectional Only (Note 4)	$V_F$	3.5/5.0	V
Operating Junction Temperature	$T_J$	-55 ~ +150	$^\circ\text{C}$
Storage Temperature	$T_{STG}$	-55 ~ +150	$^\circ\text{C}$

Notes: 1. Absolute maximum ratings are those values beyond which the device could be permanently damaged.

Absolute maximum ratings are stress ratings only and functional device operation is not implied.

2. Non-repetitive current pulse and derated above  $T_A=25^\circ\text{C}$

3. Measured on 8.3ms single half sine-wave or equivalent square wave, duty cycle=4 pulses per minute maximum.

4.  $V_F < 3.5\text{V}$  for devices of  $V_{BR} < 200\text{V}$  and  $V_F < 5.0\text{V}$  for devices of  $V_{BR} > 201\text{V}$ .

■ ELECTRICAL CHARACTERISTICS ( $T_A=25^\circ\text{C}$ , unless otherwise noted)

PART NUMBER (Uni)	BREAKDOWN VOLTAGE $V_{BR} @ I_T$			MAXIMUM REVERSE LEAKAGE $I_R$  @ $V_{RWM}$ ( $\mu\text{A}$ )	WORKING PEAK REVERSE VOLTAGE $V_{RWM}$ (V)	MAXIMUM REVERSE SURGE CURRENT $I_{PP}$ (A)	MAXIMUM CLAMPING VOLTAGE $V_C @ I_{PP}$ (V)
	MIN (V)	MAX (V)	$I_T$ (mA)				
SMDJ24A	26.70	29.50	5	2	24.0	77.12	38.9
SMDJ28A	31.10	34.40	5	2	28.0	66.08	45
SMDJ33A	36.70	40.60	5	2	33.0	56.29	53.3

■ TYPICAL CHARACTERISTICS ( $T_A=25^\circ\text{C}$ , unless otherwise noted)

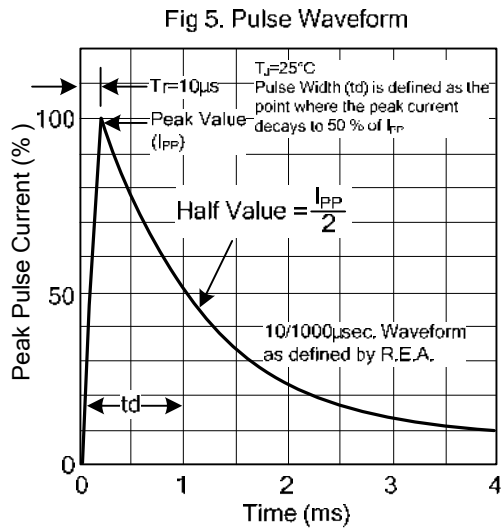
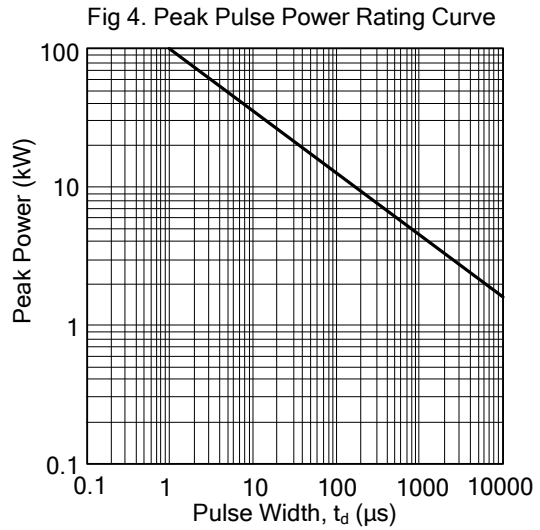
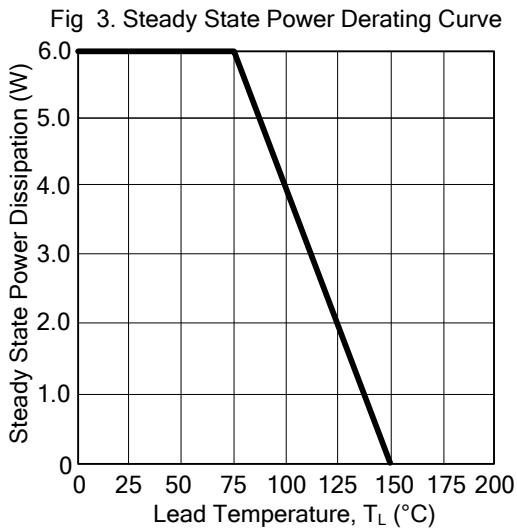
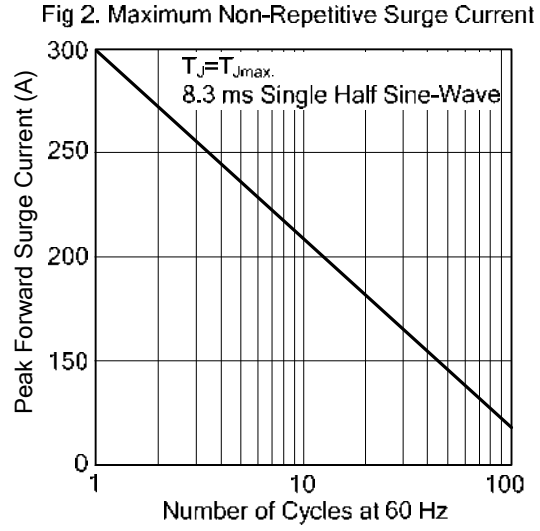
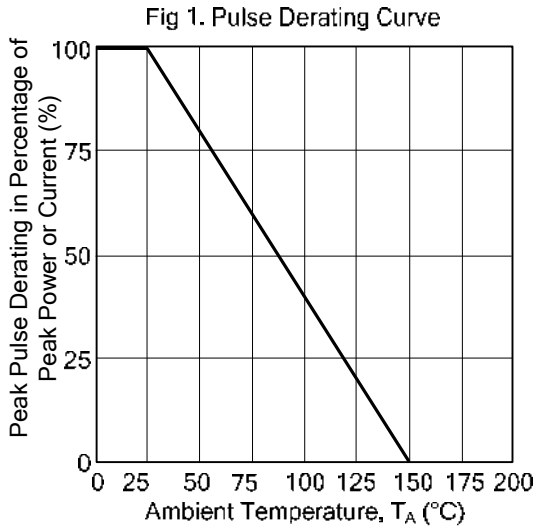

UTC assumes no responsibility for equipment failures that result from using products at values that exceed, even momentarily, rated values (such as maximum ratings, operating condition ranges, or other parameters) listed in products specifications of any and all UTC products described or contained herein. UTC products are not designed for use in life support appliances, devices or systems where malfunction of these products can be reasonably expected to result in personal injury. Reproduction in whole or in part is prohibited without the prior written consent of the copyright owner. The information presented in this document does not form part of any quotation or contract, is believed to be accurate and reliable and may be changed without notice.